

## grzejniki płytowe



### Compact (Purmo C)

Grzejniki płytowe PURMO Compact z profilowanymi płytami grzejnymi i elementami konwekcyjnymi. Wyposażone w osłony boczne i osłonę górną typu grill. Cztery otwory przyłączeniowe z gwintem wewnętrznym G ½ " umożliwiają podłączenie boczne zarówno z prawej jak i z lewej strony.

#### dane techniczne

- Materiał : wysokiej jakości głęboko tłoczna blacha ze stali niskowęglowej walcowanej na zimno FeP0 1 wg PN-EN 10130
- Rozstaw pionowych kanałów wodnych : 33,3 mm
- Przyłącza : 4 x G ½ " boczne
- Ciśnienie robocze : 10 bar
- Temperatura maksymalna : 110 °C
- Ciśnienie próbne : 13 bar
- Kolor : biały RAL 9016, inne kolory z palety RAL na zamówienie
- Akcesoria : zawieszania, korek, odpowietrznik w komplecie z grzejnikiem.



## rzuty z boku

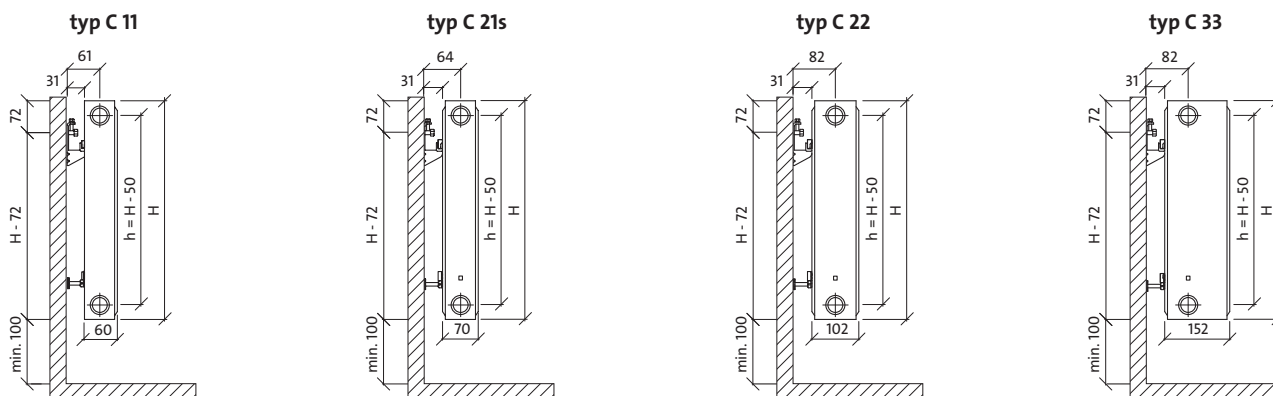

wymiary podano w [mm]

$H$  = wysokość  
 $L$  = długość  
 $h$  = rozstaw przyłączy

## widok z przodu

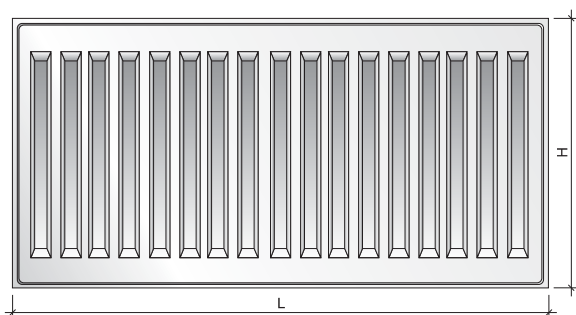

## widok z tyłu

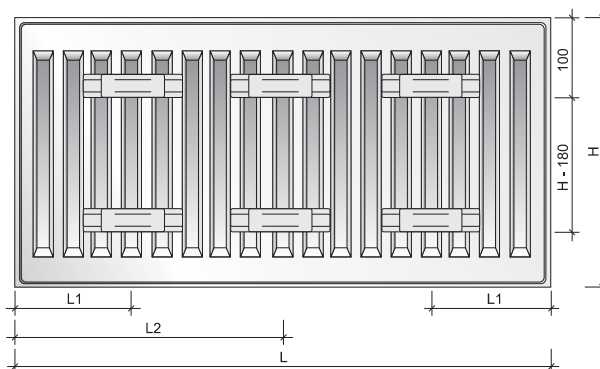

## pojemność, ciężar i odległości montażowe

pojemność : l/m

wys. typ	300	450	500	550	600	900
11	1,7	2,5	2,7	3,0	3,2	4,5
21s	3,4	5,0	5,5	6,1	6,6	9,0
22	3,4	5,0	5,5	6,1	6,6	9,0
33	5,1	7,5	8,2	9,0	9,8	13,3

ciężar : kg/m

wys. typ	300	450	500	550	600	900
11	9,1	13,9	15,5	17,1	18,7	28,3
21s	14,0	21,2	23,5	25,9	28,3	42,3
22	16,3	24,9	27,7	30,6	33,4	50,7
33	24,5	37,4	41,6	45,9	50,2	75,8

odległości montażowe : mm

typ	C 11		C 21s, C 22, C 33		
	L	L1	L2	L1	L2
400-1600	117	-	133	-	-
1800	117	917	133	900	-
2000	117	1017	133	1000	-
2300	117	1150	133	1167	-
2600	117	1317	133	1300	-
3000	117	1517	133	1500	-

## zalecane podłączenia

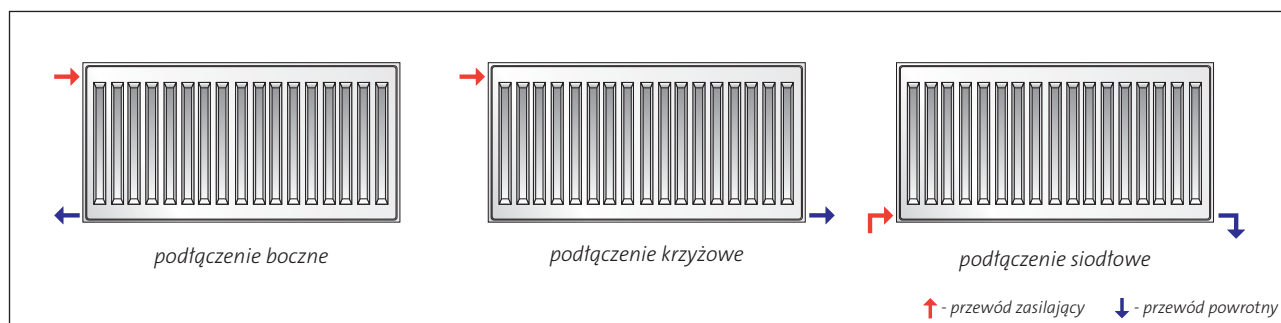

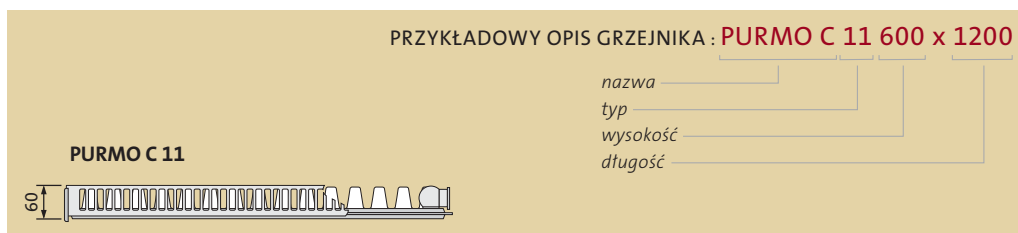

długość [mm]	parametry $t_z / t_p / t_i$	wysokość [mm]					
		300	450	500	550	600	900
400	<b>75/65/20 °C</b>	<b>218</b>	<b>316</b>	<b>347</b>	<b>378</b>	<b>407</b>	<b>571</b>
	55/45/20 °C	112	161	177	192	207	289
500	<b>75/65/20 °C</b>	<b>273</b>	<b>395</b>	<b>434</b>	<b>472</b>	<b>509</b>	<b>714</b>
	55/45/20 °C	140	201	221	240	258	361
600	<b>75/65/20 °C</b>	<b>328</b>	<b>474</b>	<b>521</b>	<b>566</b>	<b>611</b>	<b>856</b>
	55/45/20 °C	167	241	265	288	310	433
700	<b>75/65/20 °C</b>	<b>382</b>	<b>553</b>	<b>608</b>	<b>661</b>	<b>713</b>	<b>999</b>
	55/45/20 °C	195	282	309	336	362	506
800	<b>75/65/20 °C</b>	<b>437</b>	<b>632</b>	<b>694</b>	<b>755</b>	<b>814</b>	<b>1142</b>
	55/45/20 °C	223	322	353	384	413	578
900	<b>75/65/20 °C</b>	<b>491</b>	<b>711</b>	<b>781</b>	<b>850</b>	<b>916</b>	<b>1284</b>
	55/45/20 °C	251	362	398	432	465	650
1000	<b>75/65/20 °C</b>	<b>546</b>	<b>790</b>	<b>868</b>	<b>944</b>	<b>1018</b>	<b>1427</b>
	55/45/20 °C	279	402	442	480	517	722
1100	<b>75/65/20 °C</b>	<b>601</b>	<b>869</b>	<b>955</b>	<b>1038</b>	<b>1120</b>	<b>1570</b>
	55/45/20 °C	307	443	486	528	569	795
1200	<b>75/65/20 °C</b>	<b>655</b>	<b>948</b>	<b>1042</b>	<b>1133</b>	<b>1222</b>	<b>1712</b>
	55/45/20 °C	335	483	530	576	620	867
1400	<b>75/65/20 °C</b>	<b>764</b>	<b>1106</b>	<b>1215</b>	<b>1322</b>	<b>1425</b>	<b>1998</b>
	55/45/20 °C	391	563	618	672	724	1011
1600	<b>75/65/20 °C</b>	<b>874</b>	<b>1264</b>	<b>1389</b>	<b>1510</b>	<b>1629</b>	<b>2283</b>
	55/45/20 °C	447	644	707	768	827	1156
1800	<b>75/65/20 °C</b>	<b>983</b>	<b>1422</b>	<b>1562</b>	<b>1699</b>	<b>1832</b>	<b>2569</b>
	55/45/20 °C	502	724	795	864	930	1300
2000	<b>75/65/20 °C</b>	<b>1092</b>	<b>1580</b>	<b>1736</b>	<b>1888</b>	<b>2036</b>	<b>2854</b>
	55/45/20 °C	558	805	883	960	1034	1445
2300	<b>75/65/20 °C</b>	<b>1256</b>	<b>1817</b>	<b>1996</b>	<b>2171</b>	<b>2341</b>	<b>3282</b>
	55/45/20 °C	642	926	1016	1104	1189	1662
2600	<b>75/65/20 °C</b>	<b>1420</b>	<b>2054</b>	<b>2257</b>	<b>2454</b>	<b>2647</b>	<b>3710</b>
	55/45/20 °C	726	1046	1148	1248	1344	1878
3000	<b>75/65/20 °C</b>	<b>1638</b>	<b>2370</b>	<b>2604</b>	<b>2832</b>	<b>3054</b>	<b>4281</b>
	55/45/20 °C	837	1207	1325	1439	1551	2167

Moc cieplna grzejników (W) według normy PN-EN 442 dla parametrów 75/65/20 °C i 55/45/20 °C.

[W/m] 90/70/20 °C wykładnik n	686	994	1093	1189	1283	1800
	<b>1,2981</b>	<b>1,3048</b>	<b>1,3070</b>	<b>1,3093</b>	<b>1,3115</b>	<b>1,3170</b>

typy grzejników dostępne z magazynu

PRZYKŁADOWY OPIS GRZEJNIKA : **PURMO C 21s 600 x 1200**

PURMO C 21s



nazwa \_\_\_\_\_  
 typ \_\_\_\_\_  
 wysokość \_\_\_\_\_  
 długość \_\_\_\_\_



długość [mm]	parametry $t_z / t_p / t_i$	wysokość [mm]					
		300	450	500	550	600	900
400	<b>75/65/20 °C</b>	<b>304</b>	<b>424</b>	<b>462</b>	<b>500</b>	<b>536</b>	<b>744</b>
	55/45/20 °C	157	216	235	253	271	373
500	<b>75/65/20 °C</b>	<b>381</b>	<b>530</b>	<b>578</b>	<b>625</b>	<b>670</b>	<b>931</b>
	55/45/20 °C	196	271	294	317	338	466
600	<b>75/65/20 °C</b>	<b>457</b>	<b>636</b>	<b>694</b>	<b>749</b>	<b>804</b>	<b>1117</b>
	55/45/20 °C	236	325	353	380	406	559
700	<b>75/65/20 °C</b>	<b>533</b>	<b>742</b>	<b>809</b>	<b>874</b>	<b>938</b>	<b>1303</b>
	55/45/20 °C	275	379	412	443	474	652
800	<b>75/65/20 °C</b>	<b>609</b>	<b>848</b>	<b>925</b>	<b>999</b>	<b>1072</b>	<b>1489</b>
	55/45/20 °C	314	433	470	507	542	745
900	<b>75/65/20 °C</b>	<b>685</b>	<b>954</b>	<b>1040</b>	<b>1124</b>	<b>1206</b>	<b>1675</b>
	55/45/20 °C	353	487	529	570	609	838
1000	<b>75/65/20 °C</b>	<b>761</b>	<b>1060</b>	<b>1156</b>	<b>1249</b>	<b>1340</b>	<b>1861</b>
	55/45/20 °C	393	541	588	633	677	932
1100	<b>75/65/20 °C</b>	<b>837</b>	<b>1166</b>	<b>1272</b>	<b>1374</b>	<b>1474</b>	<b>2047</b>
	55/45/20 °C	432	595	647	696	745	1025
1200	<b>75/65/20 °C</b>	<b>913</b>	<b>1272</b>	<b>1387</b>	<b>1499</b>	<b>1608</b>	<b>2233</b>
	55/45/20 °C	471	649	706	760	812	1118
1400	<b>75/65/20 °C</b>	<b>1065</b>	<b>1484</b>	<b>1618</b>	<b>1749</b>	<b>1876</b>	<b>2605</b>
	55/45/20 °C	550	758	823	886	948	1304
1600	<b>75/65/20 °C</b>	<b>1218</b>	<b>1696</b>	<b>1850</b>	<b>1998</b>	<b>2144</b>	<b>2978</b>
	55/45/20 °C	628	866	941	1013	1083	1490
1800	<b>75/65/20 °C</b>	<b>1370</b>	<b>1908</b>	<b>2081</b>	<b>2248</b>	<b>2412</b>	<b>3350</b>
	55/45/20 °C	707	974	1059	1140	1218	1677
2000	<b>75/65/20 °C</b>	<b>1522</b>	<b>2120</b>	<b>2312</b>	<b>2498</b>	<b>2680</b>	<b>3722</b>
	55/45/20 °C	785	1082	1176	1266	1354	1863
2300	<b>75/65/20 °C</b>	<b>1750</b>	<b>2438</b>	<b>2659</b>	<b>2873</b>	<b>3082</b>	<b>4280</b>
	55/45/20 °C	903	1245	1353	1456	1557	2142
2600	<b>75/65/20 °C</b>	<b>1979</b>	<b>2756</b>	<b>3006</b>	<b>3247</b>	<b>3484</b>	<b>4839</b>
	55/45/20 °C	1021	1407	1529	1646	1760	2422
3000	<b>75/65/20 °C</b>	<b>2283</b>	<b>3180</b>	<b>3468</b>	<b>3747</b>	<b>4020</b>	<b>5583</b>
	55/45/20 °C	1178	1623	1764	1899	2031	2795

Moc cieplna grzejników (W) według normy PN-EN 442 dla parametrów 75/65/20 °C i 55/45/20 °C.

[W/m] 90/70/20 °C	954	1333	1456	1575	1691	2356
wykładnik n	1,2803	1,3008	1,3076	1,3145	1,3213	1,3390

typy grzejników dostępne z magazynu

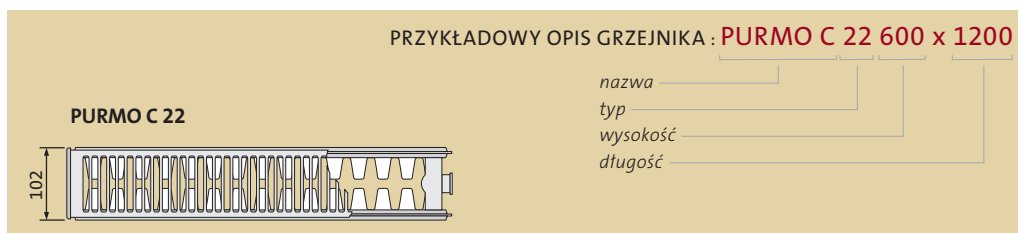

długość [mm]	parametry $t_z / t_p / t_i$	wysokość [mm]					
		300	450	500	550	600	900
400	75/65/20 °C	384	539	588	636	684	955
	55/45/20 °C	195	272	296	320	343	474
500	75/65/20 °C	481	674	735	796	855	1194
	55/45/20 °C	244	340	370	400	428	592
600	75/65/20 °C	577	808	882	955	1025	1433
	55/45/20 °C	293	408	444	480	514	711
700	75/65/20 °C	673	943	1029	1114	1196	1672
	55/45/20 °C	342	476	518	560	600	829
800	75/65/20 °C	769	1078	1176	1273	1367	1910
	55/45/20 °C	391	544	592	640	685	948
900	75/65/20 °C	865	1212	1323	1432	1538	2149
	55/45/20 °C	440	612	666	720	771	1066
1000	75/65/20 °C	961	1347	1470	1591	1709	2388
	55/45/20 °C	488	680	740	799	857	1185
1100	75/65/20 °C	1057	1482	1617	1750	1880	2627
	55/45/20 °C	537	748	814	879	943	1303
1200	75/65/20 °C	1153	1616	1764	1909	2051	2866
	55/45/20 °C	586	816	888	959	1028	1422
1400	75/65/20 °C	1345	1886	2058	2227	2393	3343
	55/45/20 °C	684	952	1037	1119	1200	1659
1600	75/65/20 °C	1538	2155	2352	2546	2734	3821
	55/45/20 °C	781	1088	1185	1279	1371	1896
1800	75/65/20 °C	1730	2425	2646	2864	3076	4298
	55/45/20 °C	879	1224	1333	1439	1542	2133
2000	75/65/20 °C	1922	2694	2940	3182	3418	4776
	55/45/20 °C	977	1360	1481	1599	1714	2370
2300	75/65/20 °C	2210	3098	3381	3659	3931	5492
	55/45/20 °C	1123	1564	1703	1839	1971	2725
2600	75/65/20 °C	2499	3502	3822	4137	4443	6209
	55/45/20 °C	1270	1768	1925	2079	2228	3080
3000	75/65/20 °C	2883	4041	4410	4773	5127	7164
	55/45/20 °C	1465	2040	2221	2398	2571	3554

Moc cieplna grzejników (W) według normy PN-EN 442 dla parametrów 75/65/20 °C i 55/45/20 °C.

[W/m] 90/70/20 °C	1211	1701	1857	2012	2163	3033
wykładnik n	1,3094	1,3226	1,3270	1,3314	1,3358	1,3561

typy grzejników dostępne z magazynu

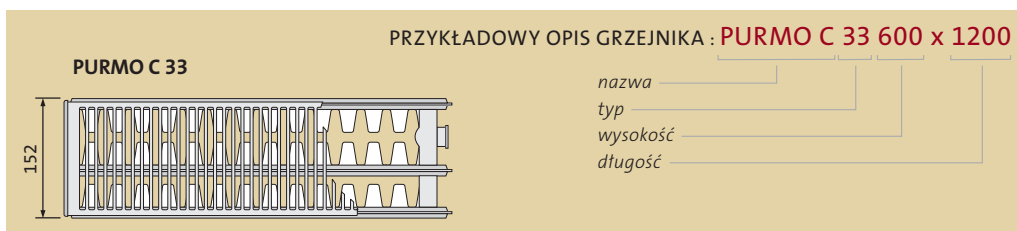

długość [mm]	parametry $t_z / t_p / t_i$	wysokość [mm]					
		300	450	500	550	600	900
400	75/65/20 °C	539	748	814	879	942	1304
	55/45/20 °C	273	376	408	439	469	646
500	75/65/20 °C	674	935	1018	1099	1178	1630
	55/45/20 °C	341	470	510	549	587	807
600	75/65/20 °C	808	1121	1221	1318	1414	1956
	55/45/20 °C	410	564	612	659	704	968
700	75/65/20 °C	943	1308	1425	1538	1649	2282
	55/45/20 °C	478	657	714	768	821	1130
800	75/65/20 °C	1078	1495	1628	1758	1885	2608
	55/45/20 °C	546	751	816	878	939	1291
900	75/65/20 °C	1212	1682	1832	1977	2120	2934
	55/45/20 °C	615	845	918	988	1056	1453
1000	75/65/20 °C	1347	1869	2035	2197	2356	3260
	55/45/20 °C	683	939	1020	1098	1173	1614
1100	75/65/20 °C	1482	2056	2239	2417	2592	3586
	55/45/20 °C	751	1033	1122	1207	1291	1776
1200	75/65/20 °C	1616	2243	2442	2636	2827	3912
	55/45/20 °C	820	1127	1224	1317	1408	1937
1400	75/65/20 °C	1886	2617	2849	3076	3298	4564
	55/45/20 °C	956	1315	1427	1537	1643	2260
1600	75/65/20 °C	2155	2990	3256	3515	3770	5216
	55/45/20 °C	1093	1503	1631	1756	1877	2583
1800	75/65/20 °C	2425	3364	3663	3955	4241	5868
	55/45/20 °C	1229	1691	1835	1976	2112	2905
2000	75/65/20 °C	2694	3738	4070	4394	4712	6520
	55/45/20 °C	1366	1878	2039	2195	2347	3228
2300	75/65/20 °C	3098	4299	4681	5053	5419	7498
	55/45/20 °C	1571	2160	2345	2524	2699	3713
2600	75/65/20 °C	3502	4859	5291	5712	6126	8476
	55/45/20 °C	1776	2442	2651	2854	3051	4197
3000	75/65/20 °C	4041	5607	6105	6591	7068	9780
	55/45/20 °C	2049	2818	3059	3293	3520	4842

Moc cieplna grzejników (W) według normy PN-EN 442 dla parametrów 75/65/20 °C i 55/45/20 °C.

[W/m] 90/70/20 °C	1698	2363	2576	2784	2988	4143
wykładnik n	1,3140	1,3313	1,3371	1,3428	1,3486	1,3600

typy grzejników dostępne z magazynu